

SGCD4

Switchable Gain Photocurrent Digitizer

GENERAL FEATURES



Properties of the SGCD4

The SGCD4 is a switchable gain photocurrent digitizer that converts small DC currents (e.g. generated by photodiodes) into digital values transmitted via USB to a computer for displaying and recording. Four different current measurement ranges are user selectable by software. The device is delivered with a PTB traceable current calibration.

SPECIFICATIONS

	Parameter	Value
	Current measurement range 1 (end of range)	1 nA
	Current measurement range 2 (end of range)	30 nA
	Current measurement range 3 (end of range)	1 µA
	Current measurement range 4 (end of range)	30 µA
	Maximum input current	30 µA
	Measurement range control	by software
	Operating temperature range (non condensing)	-20 to +80 °C
	Storage temperature range (non condensing)	-20 to +80 °C
	Dimensions (width x length x height)	80 x 130 x 28 mm

We strongly recommend to process this product on ESD protected workplaces.

▶ BLOCK DIAGRAM

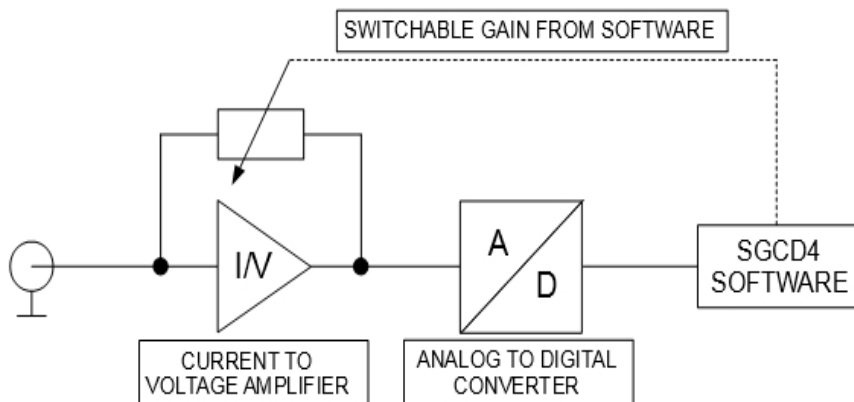

▶ SOFTWARE - INSTRUCTIONS

Installation instructions

Navigate to <https://download.sglux.de/amplifiers/sgcd4> and download “sglux-sgcd4-*-setup.exe”, start it and follow the instructions. We recommend to keep all settings to default and to just press next/next/.../finish.

Information about the software being installed on your computer

The install wizard will install three software modules:

1. USB serial port driver (2 MB, manufacturer FTDI)
2. Labview runtime engine (280 MB, manufacturer National Instruments)
3. SGCD4 Software (10 MB, manufacturer sglux)

To install updates please download [sglux-sgcd4-*-update.exe](#).

SOFTWARE - INSTRUCTIONS

▶ 3/6

Usage instructions for uvPLOT SGCD4

After installing the prerequisites and the program connect the SGCD4 unit to the computer and open the program uvPLOT SGCD4.

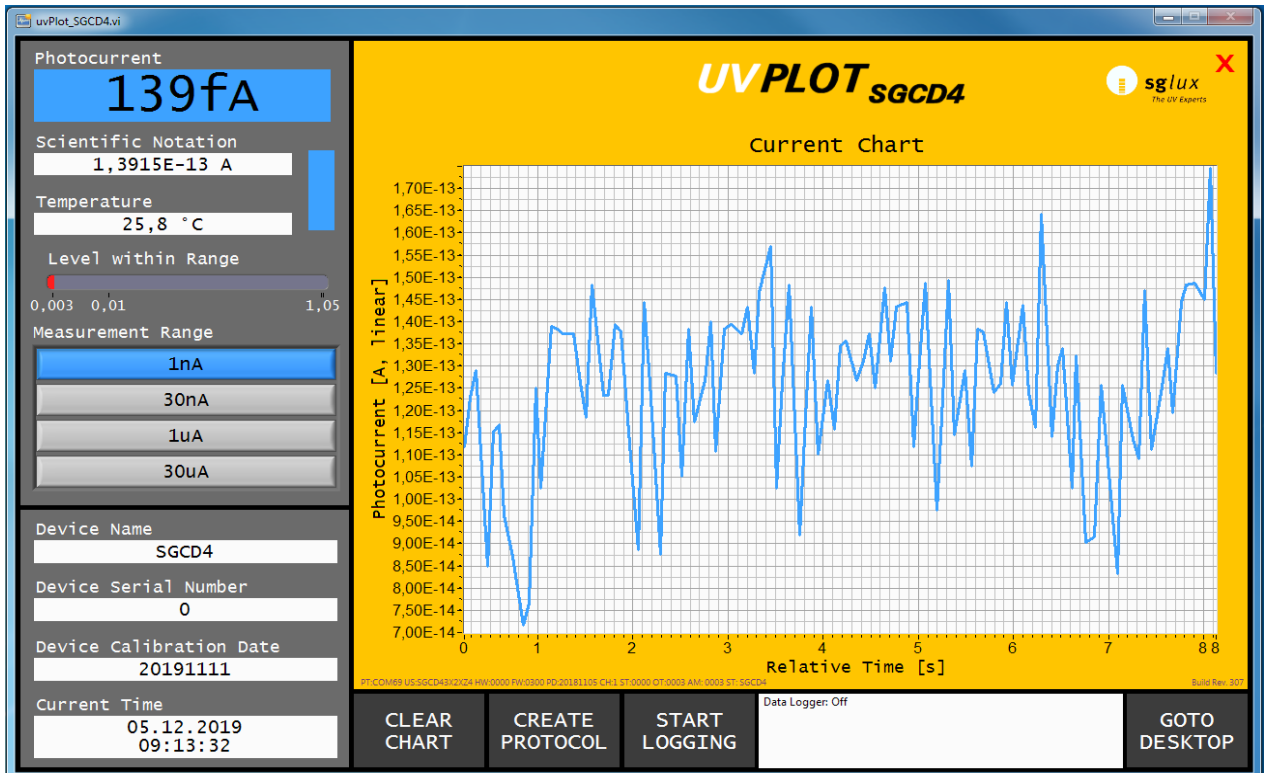

By default, the smallest measurement range is selected.



The “Level within range” indicator shows the signal level within the currently selected measurement range. It is green if the measurement range is appropriate for the given current.

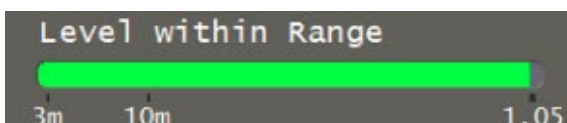

SOFTWARE - INSTRUCTIONS

If it is red the signal current is either too small or too large for the selected measurement range. If possible change the range accordingly.

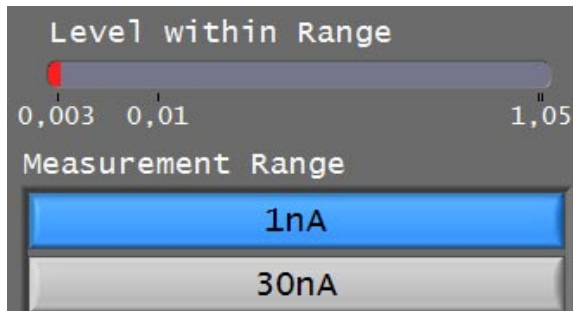

The measurement range can be changed by clicking one of the 4 buttons. Your selection will be marked blue and is immediately effective.

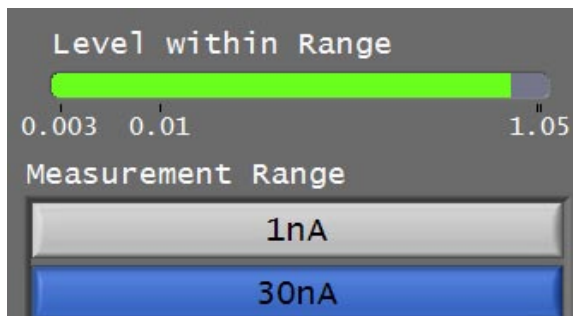

CREATE PROTOCOL - Button



Clicking this button creates a HTML file with an overview of all sensor data and a chart of the current measurement. This file is saved in the installation folder and can be opened with any web-browser.

START / STOP LOGGING - Buttons

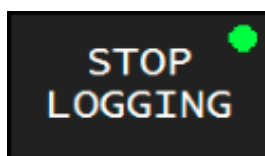
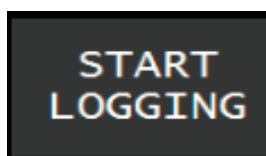

Activation this button creates a CSV file and all subsequent sensor readings are recorded. The file can be found in the installation folder. During data logging, it is not possible to change the measurement range. For this the logging must be interrupted.

► SOFTWARE - INSTRUCTIONS

CHANGING THE CHART SCALE

To change the chart scale from linear to logarithmic or from logarithmic to linear click and hold on the axis title and swipe down or up.

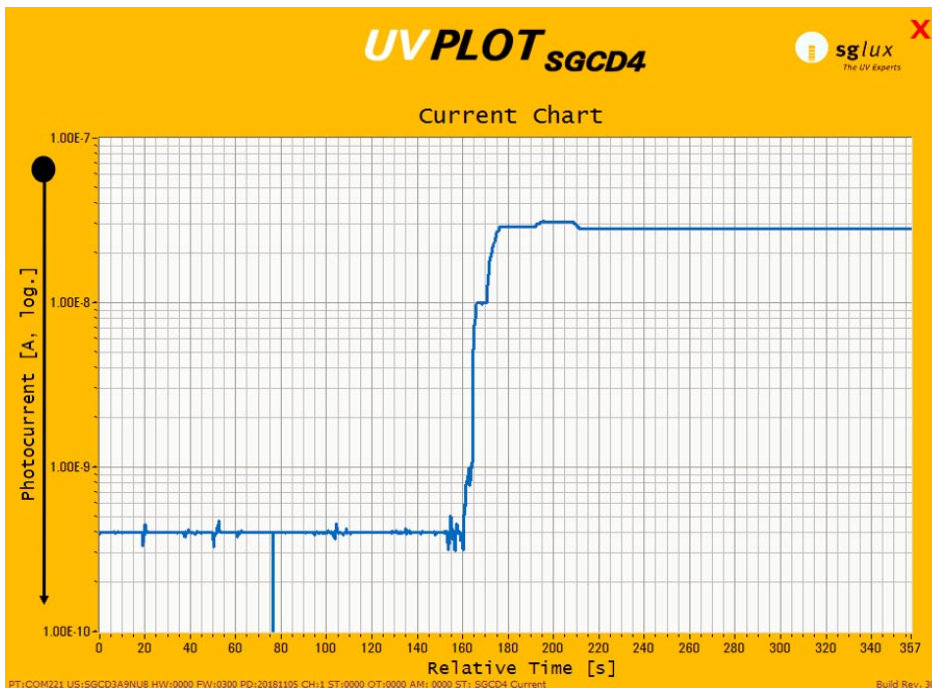

► PERFORMANCE DEPENDING ON GAIN SETTING

	Range 1	Range 2	Range 3	Range 4
End of range current	1 nA	30 nA	1 µA	30 µA
Input noise current (peak to peak)	120 fA	400 fA	8 pA	200 pA
Time constant (T)	102 ms	103 ms	102 ms	100 ms
Settling time (5*T)	510 ms	515 ms	510 ms	500 ms
Cutoff frequency (-3dB)	1.6 Hz			
Temperature coefficient (ppm/K)	-300	-280	360	50

SGCD4

Switchable Gain Photocurrent Digitizer

 DRAWING

